

ASME Certified STANDARD Vessel Construction

The only boiler vessel built specifically for waste oil from the ground up. Our heavy carbon-steel construction is stronger and more efficient than cast-iron and coil-tube boilers provided by other brands.

Safety STANDARD

- Low water cut off
- High temperature limit
- Pressure relief valve
- Triple aquastat

Optional Integrated Domestic Hot Water Coil

An open loop domestic coil can be added to run closed and open loops simultaneously. Provides hot water for restrooms, carwash, dishwashers and more. Unit can operate as a stand-alone system using the hot water coil.

Removable Rear Panel EXCLUSIVE

Speeds and simplifies straight-through cleaning (see below).

Small Footprint STANDARD

Saves space and makes installation simpler and more flexible with unit stacking and flue options.

Digital Hour Meter STANDARD

Tracks runtime

Wet Floor Based Heat Exchanger STANDARD

Water-cooled heat exchanger prevents hot spots and deterioration.

Metering Fuel Pump PATENTED

Reliable, consistent fuel delivery regardless of fuel type (up to 90W) with no manual adjustments.

Integrated Air Compressor STANDARD

Built in so you don't have to connect to and rely on shop air, providing 24/7 heating availability.

Accutemp Preheater PATENTED

Rapidly heats the widest range of viscosities of used oil, synthetic oil and other acceptable fuels.



Pictured: 375B boiler

Easy Access & Maintenance

Flame Retention Head PATENTED

This patented design creates a hotter flame for complete fuel combustion and highest heat output. Less ash is produced resulting in longer maintenance intervals than competing brands.

Swing Open Boiler Door STANDARD

Easy access to the firing chamber for cleaning



Advanced Features

AquaSmart™ Technology

Built-in memory and system history provides diagnostics for efficient operation

Dynamic Temperature Reset

Dynamic temperature reset decreases fuel consumption by up to 20%

Backlit Display with Touch-Pad

Back-lit LCD display with touch-pad makes programming temperature limits, differentials and other options easy

Pressure Gauge

Analog pressure gauge continually displays conditions



200B



375B



500B



Boilers

	ENGLISH	METRIC	ENGLISH	METRIC	ENGLISH	METRIC
BTU Input	200,000 BTU per hour	58.3 kW per hour	375,000 BTU per hour	110 kW per hour	499,000 BTU per hour	146 kW per hour
Fuel Flow Rate	1.4 gallons/hour	5.3 liters/hour	2.7 gallons/hour	10.2 liters/hour	3.6 gallons/hour	13.6 liters/hour
Water Output Temp. (max)	230 F	110 C	230 F	110 C	230 F	110 C
Domestic Hot Water Output	4 gal/min at 100 F temp rise	15 liters/min at 37.8 C temp rise	6 gal/min at 100 F temp rise	22 liters/min at 37.8 C temp rise	1 coil: 8 gal/min at 100 F 2 coils: 16 gal/min lower	1 coil: 30 liters/min at 37.8 C 2 coils: 60 liters/min lower
Boiler Capacity	30 gallons	114 liters	43 gallons	162.75 liters	52 gallons	200 liters
Inlet Water Temp.	140 F minimum	60 C minimum	140 F minimum	60 C minimum	140 F minimum	60 C minimum
Exhaust Flue Diameter	8" diameter	20.32 cm diameter available	8" diameter	20.32 cm diameter	10" diameter	25.4 cm diameter
System Dimensions	45" H x 32" W x 50" D	114 cm H x 82 cm W x 127 cm D	42" H x 28" W x 60" D	107 cm H x 71 cm W x 152 cm D	45" H x 32" W x 68" D	114 cm H x 82cm W x 173 cm D
Shipping Weight	790 lbs	358.34 kg	1042 lbs	472.64 kg	1160 lbs	526.17 kg
Shipping Weight w/ 250 gal Tank	1237 lbs	561 kg	1450 lbs	656 kg	1550 lbs	705 kg

Optimum performance to heat water for multiple applications

- In-floor radiant heat
- Ice melt
- Hot water for carwash
- Potable water
- Built in capability to run open and closed loop systems

Operating Pressure

Low pressure, 30 psi

Approved Fuels

Used crankcase oils, ATF, No. 2 fuel oil, up to 90 weight gear oil and diesel fuel

Electrical Req.

115 VAC 60Hz, 25 amps | maximum dedicated circuit

Warranty

10 years on boiler vessel, five years full and five years prorated
Up to 2 years on parts**

Regulation and Certification

- EPA-approved
- UL-listed system
- ASME-certified vessel
- Canadian Registration (CRN) available in approved provinces for waste oil heating

**One year warranty standard. Second year warranty requires product registration within 30 days of product receipt.

Storage Tanks Sold separately

Optional UL and CUL listed, workbench tanks are designed specifically for the use of waste oil heating with firematic safety valves, water drain valves and side suction port. Available in several sizes including 70 gallon, 130 gallon, 250 gallon* and 500 gallon*.

*Single and double-wall available.



5901 Crossings Boulevard | Antioch, TN 37013

(800) 335-3092 | www.energylogic.com

2011-98030056

MODEL EL-500B

- UL LISTED, ASME CERTIFIED BOILER
- FIRE TUBE: WATER IS HEATED BY HOT GASES FLOWING THROUGH 24 HORIZONTAL TUBES
- WET BASED: COMBUSTION CHAMBER AND TUBES COMPLETELY SURROUNDED BY WATER
- NON CONDENSING: HOT GASES NOT ALLOWED TO COOL, THEREBY REDUCING CONDENSATION
- MATERIAL: ASME CERTIFIED 1/4" CARBON STEEL
- BOILER WATER CAPACITY: 52 GAL
- WATER PRESSURE: 30 PSI MAXIMUM
- INLET WATER TEMPERATURE: 140°F MINIMUM
- OPERATING TEMPERATURE: 230°F MAXIMUM
- DOMESTIC HOT WATER COIL RATING: 8.0 GPM
- BOILER WEIGHT WITH BURNER: APPROXIMATELY 1,300 LBS
- WET WEIGHT: APPROXIMATELY 2,000 LBS

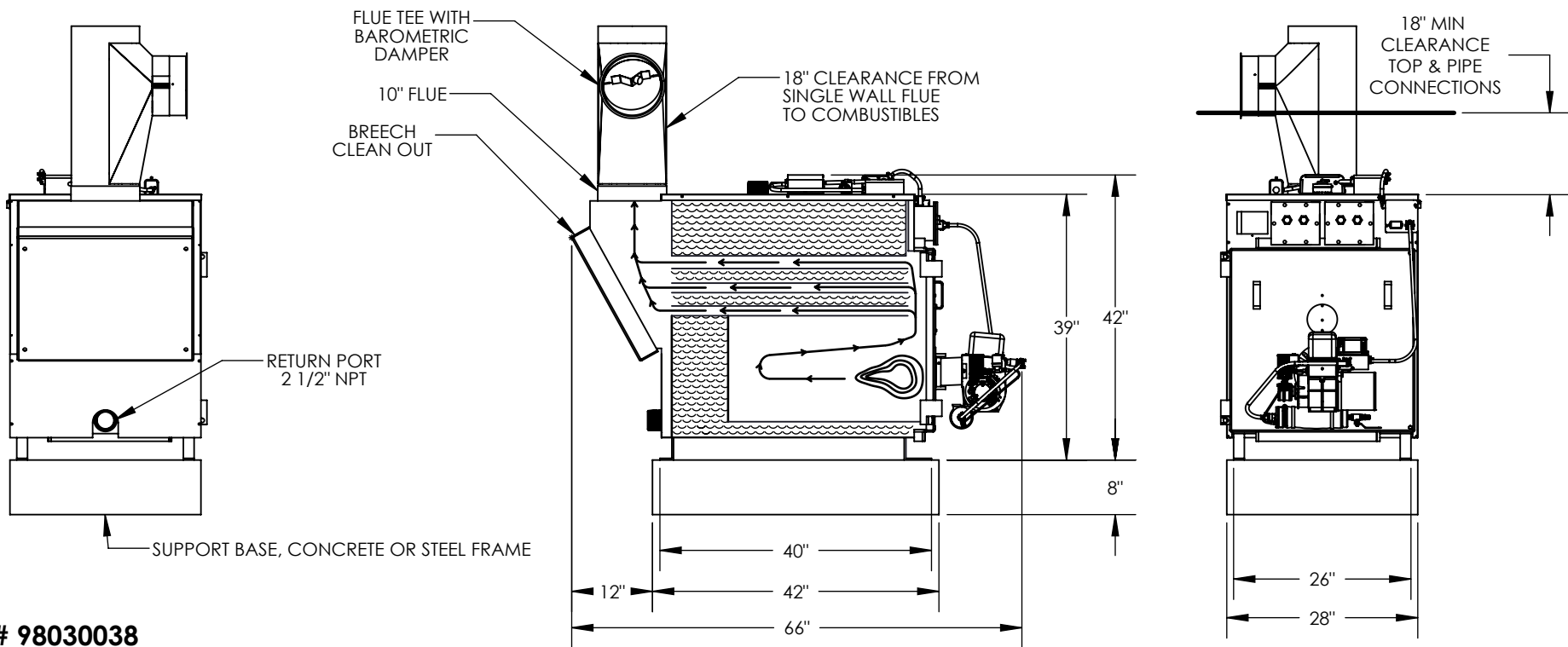
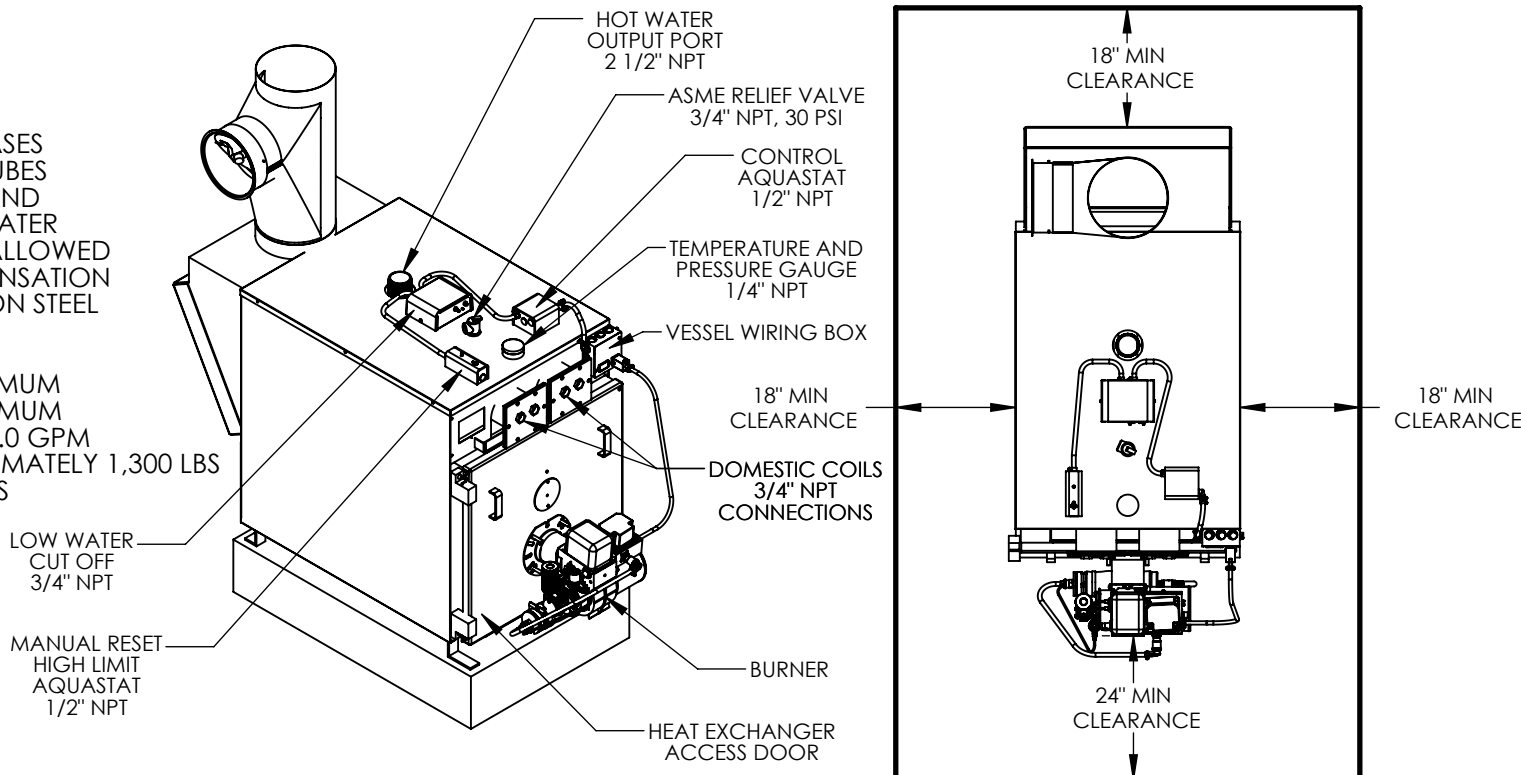

ITEM # 98030038